

Solutions to Chapter 12

12.1

1. 5   3. 13   5.  $2\sqrt{5}$    7. 13   9.  $\sqrt{13}$    11. 6   13.  $2\sqrt{2}$    15.  $\sqrt{65}$    17.  $\frac{\sqrt{13}}{12}$    19.  $\sqrt{13}$   
 21. 14   23.  $\sqrt{9+4a^2}$    25. (6,6)   27.  $(-\frac{1}{2}, \frac{5}{2})$    29.  $(\frac{7}{2}, 6)$    31.  $(-\frac{5}{2}, \frac{3}{2})$    33. (3,4)   35. (6,1)  
 37. (2,1)   39. (2,-3)   41.  $(-\frac{27}{80}, \frac{1}{24})$    43.  $(\frac{\sqrt{6}}{2}, \frac{\sqrt{7}}{2})$    45.  $(\frac{\sqrt{8}-\sqrt{5}}{2}, \frac{\sqrt{3}-\sqrt{6}}{2})$    47.  $(\frac{p+q}{2}, \frac{p+q}{2})$

Section 12.2

1.

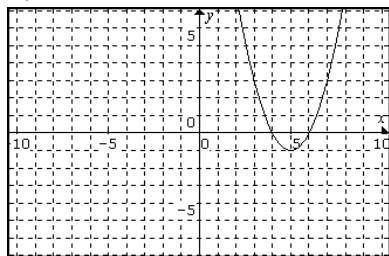

vertex: (5,-1)  
 x-int: (6,0) and (4,0)  
 y-int: (0,24)

3.

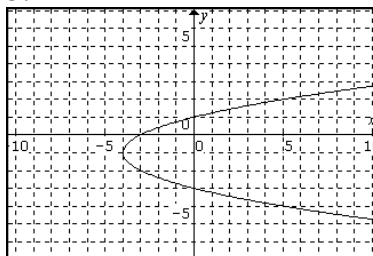

vertex: (-4,-1)  
 x-int: (-3,0)  
 y-int: (0,-3) and (0,1)

5.

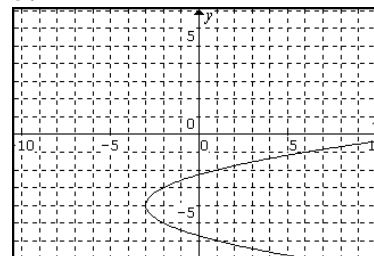

vertex: (-3,-4)  
 x-int: (13,0)  
 y-int:  
 $(0, -4 + \sqrt{3})$  and  $(0, -4 - \sqrt{3})$   
 $\approx (0, -2.27) \approx (0, -5.73)$

7.

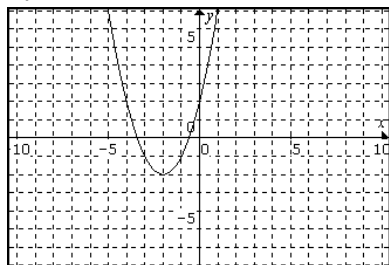

vertex: (-2,-2)  
 x-int:  
 $(-2 + \sqrt{2}, 0)$  and  $(-2 - \sqrt{2}, 0)$   
 $\approx (-0.59, 0) \approx (-3.41, 0)$   
 y-int: (0,2)

9.

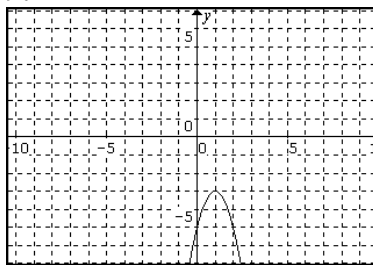

vertex: (1,-3)  
 x-int: None  
 y-int: (0,-5)

11.

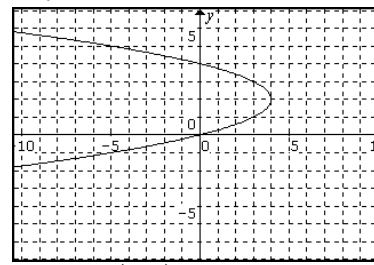

vertex: (4,2)  
 x-int: (0,0)  
 y-int: (0,0) and (0,4)

13.

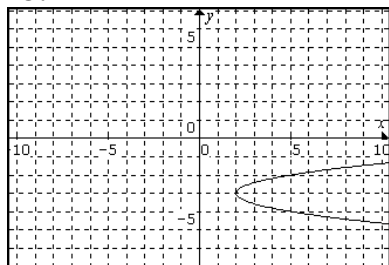

vertex: (2,-3)  
 x-int: (29,0)  
 y-int: None

15.

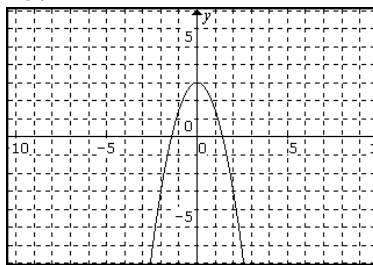

vertex: (0,3)  
 x-int:  $(\sqrt{2}, 0)$  and  $(-\sqrt{2}, 0)$   
 $\approx (1.41, 0) \approx (-1.41, 0)$   
 y-int: (0,3)

17.

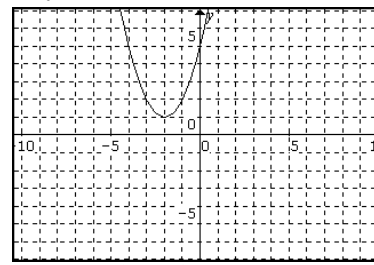

vertex: (-2,1)  
 x-int: None  
 y-int: (0,5)

19.

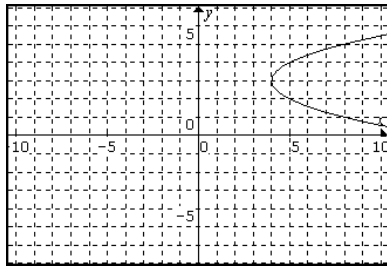

vertex:  $(4, -3)$   
 x-int:  $(13, 0)$   
 y-int: None

21.

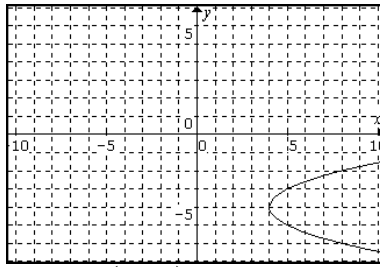

vertex:  $(4, -4)$   
 x-int:  $(20, 0)$   
 y-int: None

23.

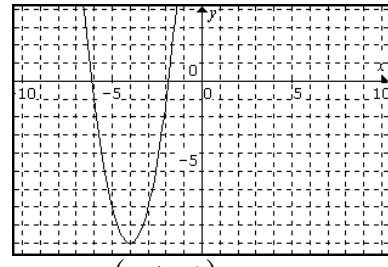

vertex:  $(-4, -9)$   
 x-int:  $(-4 + \frac{3\sqrt{2}}{2}, 0)$  and  $(-4 - \frac{3\sqrt{2}}{2}, 0)$   
 $\approx (-1.88, 0) \approx (-6.12, 0)$   
 y-int:  $(0, 23)$

25.

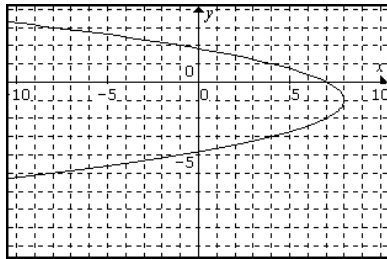

vertex:  $(8, -1)$   
 x-int:  $(7, 0)$   
 y-int:  
 $(0, -1 + 2\sqrt{2})$  and  $(0, -1 - 2\sqrt{2})$   
 $\approx (0, 1.83) \approx (0, -3.83)$

27.

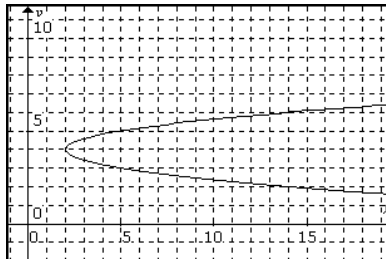

vertex:  $(2, 4)$   
 x-int:  $(50, 0)$   
 y-int: None

29.

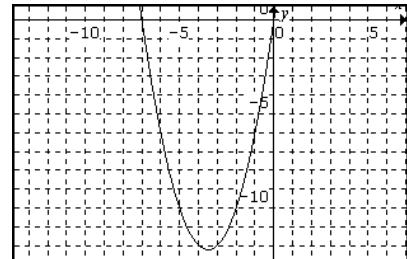

vertex:  $(-\frac{7}{2}, -\frac{49}{4})$   
 x-int:  $(0, 0)$  and  $(-7, 0)$   
 y-int:  $(0, 0)$

31.

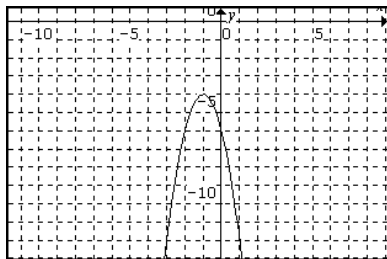

vertex:  $(-1, -4)$   
 x-int: None  
 y-int:  $(0, -6)$

33.

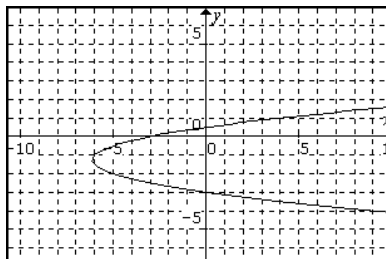

vertex:  $(-\frac{49}{8}, -\frac{5}{4})$   
 x-int:  $(-3, 0)$   
 y-int:  $(0, \frac{1}{2})$  and  $(0, -3)$

35.

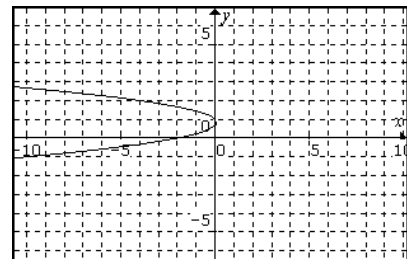

vertex:  $(\frac{1}{12}, \frac{5}{6})$   
 x-int:  $(-2, 0)$   
 y-int:  $(0, 1)$  and  $(0, \frac{2}{3})$

37.

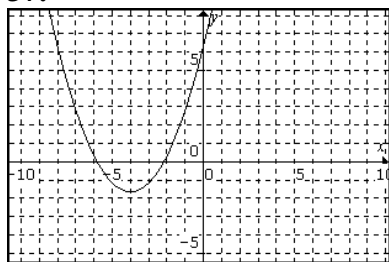
vertex:  $(-4, -\frac{5}{3})$ 

x-int:

 $(\frac{-12+\sqrt{30}}{3}, 0)$  and  $(\frac{-12-\sqrt{30}}{3}, 0)$  $\approx (-2.17, 0) \approx (-5.83, 0)$ y-int:  $(0, \frac{19}{3})$ 

39.

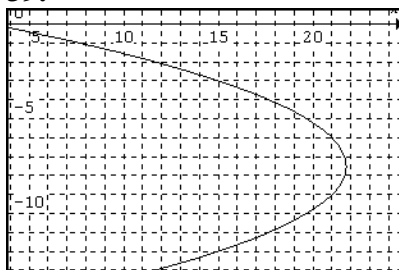
vertex:  $(\frac{87}{4}, -\frac{15}{2})$ x-int:  $(3, 0)$ 

y-int:

 $(0, \frac{-15+3\sqrt{29}}{2})$  and  $(0, \frac{-15-3\sqrt{29}}{2})$  $\approx (0, 0.58) \approx (0, -15.58)$ 

41.

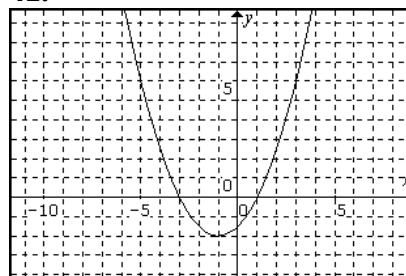
vertex:  $(-1, -2)$ x-int:  $(1, 0)$  and  $(-3, 0)$ y-int:  $(0, -\frac{3}{2})$ 

43.

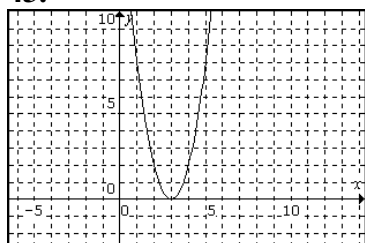
vertex:  $(3, 0)$ x-int:  $(3, 0)$ y-int:  $(0, 18)$ 

45.

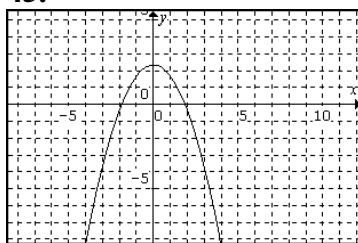
vertex:  $(0, \frac{7}{3})$ x-int:  $(\frac{\sqrt{14}}{2}, 0)$  and  $(-\frac{\sqrt{14}}{2}, 0)$  $\approx (1.87, 0) \approx (-1.87, 0)$ y-int:  $(0, \frac{7}{3})$ 

47.

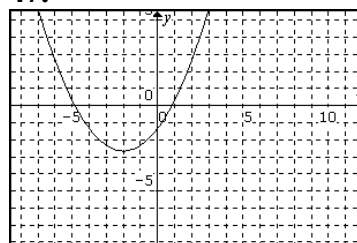
vertex:  $(-2, -\frac{8}{3})$ 

x-int:

 $(-2+2\sqrt{2}, 0)$  and  $(-2-2\sqrt{2}, 0)$  $\approx (0.83, 0) \approx (-4.83, 0)$ y-int:  $(0, -\frac{4}{3})$ 

49.  $y = 3(x+1)^2 + 3$  51.  $x = -\frac{4}{9}(y+2)^2 + 5$  53.  $x = -\frac{2}{5}(y-5)^2 + 6$  55.  $y = \frac{6}{25}(x-3)^2$

## Section 12.3

1.

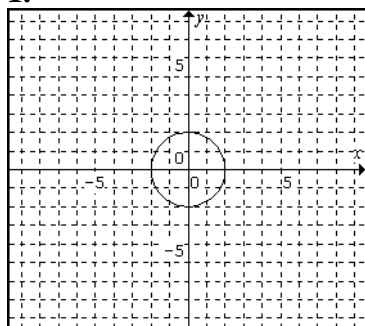
Center:  $(0, 0)$ 

Radius: 2

x-int:  $(\pm 2, 0)$ y-int:  $(0, \pm 2)$ 

3.

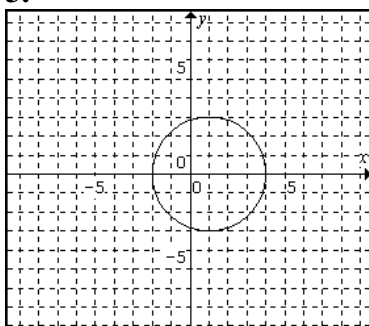
Center:  $(1, 0)$ 

Radius: 3

x-int:  $(4, 0)$  and  $(-2, 0)$ y-int:  $(0, \pm 2\sqrt{2}) \approx (0, \pm 2.83)$ 

5.

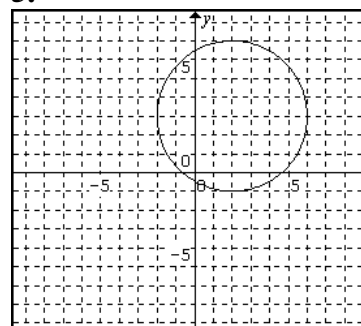
Center:  $(2, 3)$ 

Radius: 4

x-int:  $(2+\sqrt{7}, 0) \approx (4.65, 0)$  $(2-\sqrt{7}, 0) \approx (-0.65, 0)$ y-int:  $(0, 3+2\sqrt{3}) \approx (0, 6.46)$  $(0, 3-2\sqrt{3}) \approx (0, -0.46)$

7.

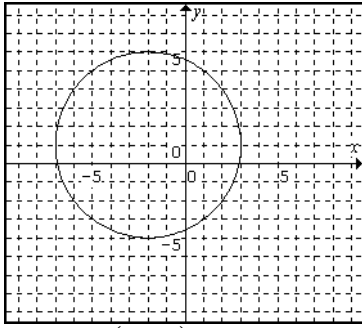
Center:  $(-2, 1)$ 

Radius: 5

$$x\text{-int: } (-2 + 2\sqrt{6}, 0) \approx (2.9, 0)$$

$$(-2 - 2\sqrt{6}, 0) \approx (-6.9, 0)$$

$$y\text{-int: } (0, 1 + \sqrt{21}) \approx (0, 5.58)$$

$$(0, 1 - \sqrt{21}) \approx (0, -3.58)$$

13.

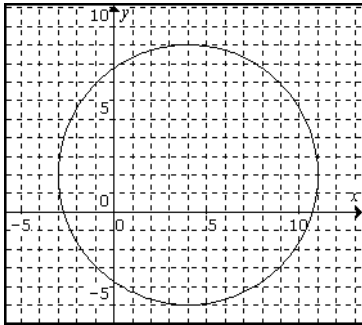
Center:  $(4, 2)$ 

Radius: 7

$$x\text{-int: } (4 + 3\sqrt{5}, 0) \approx (10.71, 0)$$

$$(4 - 3\sqrt{5}, 0) \approx (-2.71, 0)$$

$$y\text{-int: } (0, 2 + \sqrt{33}) \approx (0, 7.74)$$

$$(0, 2 - \sqrt{33}) \approx (0, -3.74)$$

19.

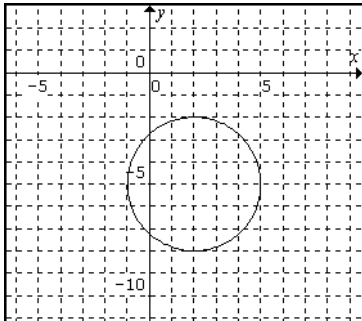
Center:  $(2, -5)$ 

Radius: 3

No x-intercepts

$$y\text{-int: } (0, -5 + \sqrt{5}) \approx (0, -2.76)$$

$$(0, -5 - \sqrt{5}) \approx (0, -7.24)$$

9.

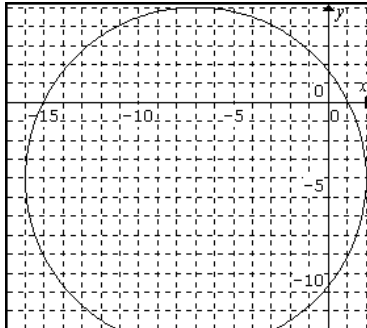
Center:  $(-7, -4)$ 

Radius: 9

$$x\text{-int: } (-7 + \sqrt{65}, 0) \approx (1.06, 0)$$

$$(-7 - \sqrt{65}, 0) \approx (-15.06, 0)$$

$$y\text{-int: } (0, -4 + 4\sqrt{2}) \approx (0, 1.66)$$

$$(0, -4 - 4\sqrt{2}) \approx (0, -9.66)$$

15.

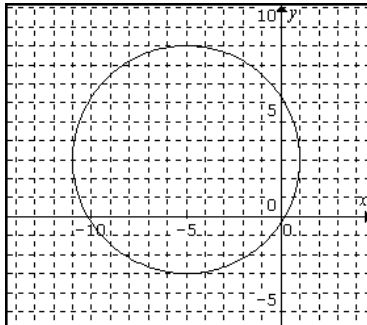
Center:  $(-5, 3)$ 

Radius: 6

$$x\text{-int: } (-5 + 3\sqrt{3}, 0) \approx (0.20, 0)$$

$$(-5 - 3\sqrt{3}, 0) \approx (-10.20, 0)$$

$$y\text{-int: } (0, 3 + \sqrt{11}) \approx (0, 6.32)$$

$$(0, 3 - \sqrt{11}) \approx (0, -0.32)$$

21.

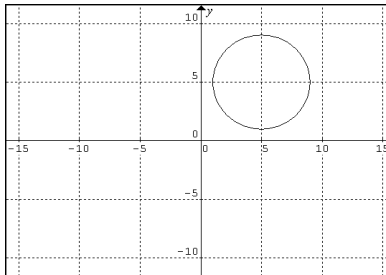
Center:  $(5, 5)$ 

Radius: 4

No x- and y-intercepts

11.

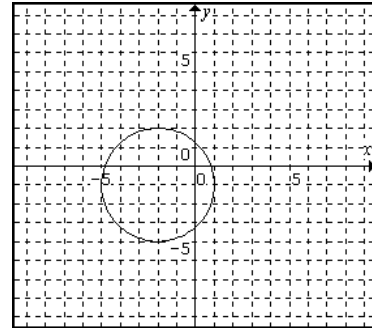
Center:  $(-2, -1)$ 

Radius: 3

$$x\text{-int: } (-2 + 2\sqrt{2}, 0) \approx (0.83, 0)$$

$$(-2 - 2\sqrt{2}, 0) \approx (-4.83, 0)$$

$$y\text{-int: } (0, -1 + \sqrt{5}) \approx (0, 1.24)$$

$$(0, -1 - \sqrt{5}) \approx (0, -3.24)$$

17.

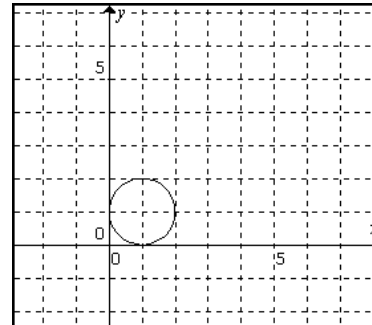
Center:  $(1, 1)$ 

Radius: 1

x-int:  $(1, 0)$ y-int:  $(0, 1)$ 

23.

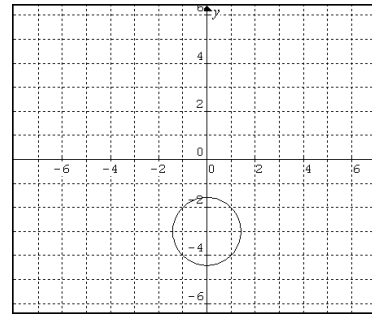
Center:  $(0, -3)$ Radius:  $\sqrt{2}$ 

No x-intercepts

$$y\text{-int: } (0, -3 + \sqrt{2}) \approx (0, -1.59)$$

$$(0, -3 - \sqrt{2}) \approx (0, -4.41)$$

25.

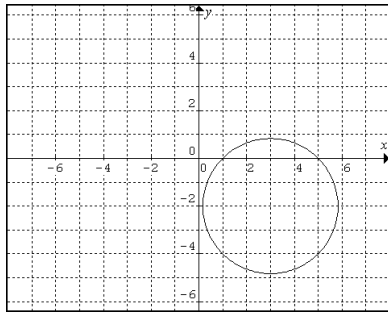

Center: (3, -2)

Radius:  $2\sqrt{2}$

x-int: (5, 0), (1, 0)

No y-intercepts

31.

Circle

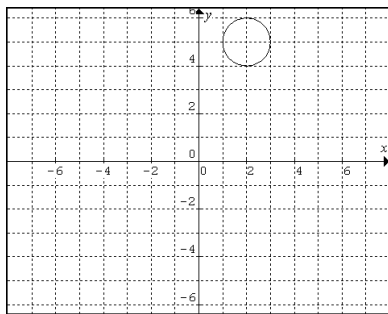

27.

Parabola

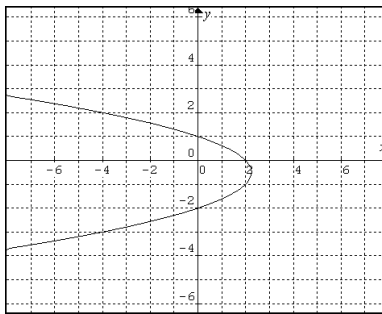

29.

Circle

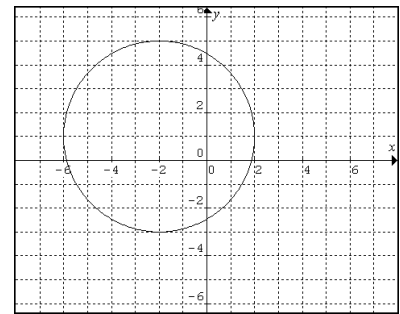

33.

Parabola

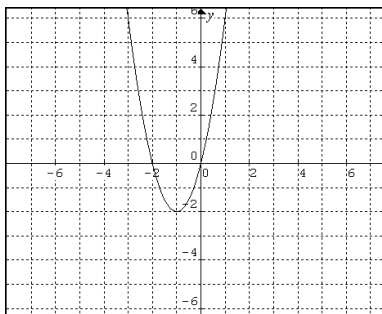

35.  $(x+1)^2 + (y-3)^2 = 9$

37.  $(x+1)^2 + (y-1)^2 = 25$

39.  $(x-1)^2 + (y-\frac{5}{2})^2 = \frac{25}{4}$

41.  $(x+2)^2 + (y-1)^2 = 20$

43.  $25\pi \approx 78.5$

45.  $16\pi \approx 50.3$

47.  $36\pi \approx 113.1$

49.  $\pi \approx 3.14$

51.  $5\pi \approx 15.7$

### Section 12.4

1.

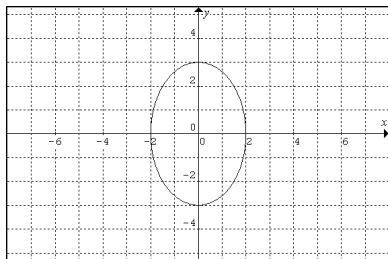

Center: (0, 0)

Vert: (0, 3), (0, -3)

x-int: (2, 0), (-2, 0)

y-int: (0, 3), (0, -3)

3.

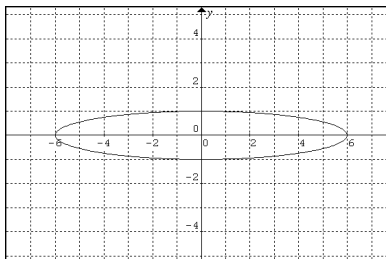

Center: (0, 0)

Vert: (6, 0), (-6, 0)

x-int: (6, 0), (-6, 0)

y-int: (0, 1), (0, -1)

5.

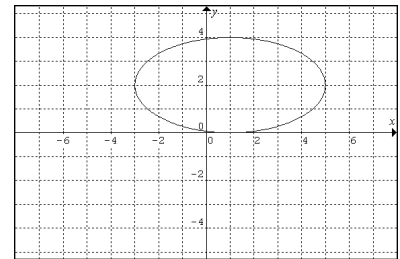

Center: (1, 2)

Vert: (5, 2), (-3, 2)

x-int: (1, 0)

y-int:

$(0, 2 \pm \frac{\sqrt{15}}{2}) \approx (0, 3.9), (0, 0.1)$

7.

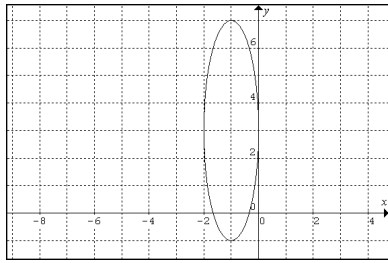

Center:  $(-1, 3)$

Vert:  $(-1, -1), (-1, 7)$

x-int:

$$\left(-1 \pm \frac{\sqrt{7}}{2}, 0\right) \approx (-2.3, 0), (0.3, 0)$$

y-int:

$$\left(0, 3 \pm \frac{\sqrt{3}}{2}\right) \approx (0, 3.9), (0, 2.1)$$

9.

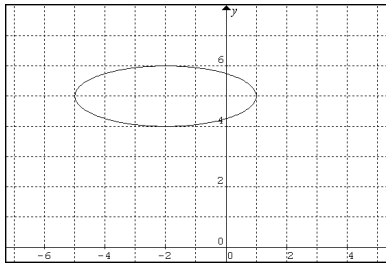

Center:  $(-2, 5)$

Vert:  $(1, 5), (-5, 5)$

x-int: none

y-int:

$$\left(0, 5 \pm \frac{\sqrt{5}}{3}\right) \approx (0, 5.7), (0, 4.3)$$

11.

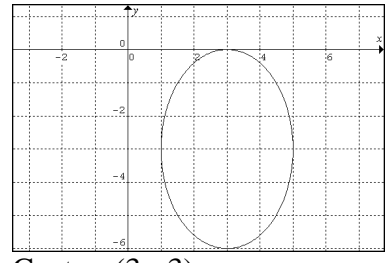

Center:  $(3, -3)$

Vert:  $(3, 0), (3, -6)$

x-int:  $(3, 0)$

y-int: none

13.

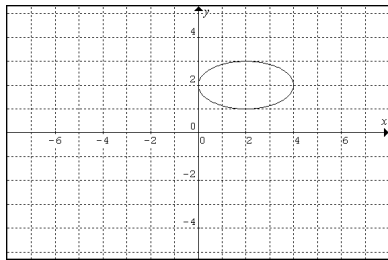

Center:  $(2, 2)$

Vert:  $(0, 2), (4, 2)$

x-int: none

y-int:  $(0, 2)$

15.

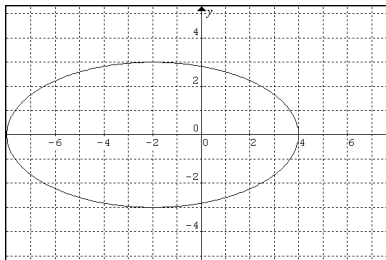

Center:  $(-2, 0)$

Vert:  $(-8, 0), (4, 0)$

x-int:  $(-8, 0), (4, 0)$

y-int:  $(0, \pm 2\sqrt{2}) \approx (0, \pm 2.8)$

17.

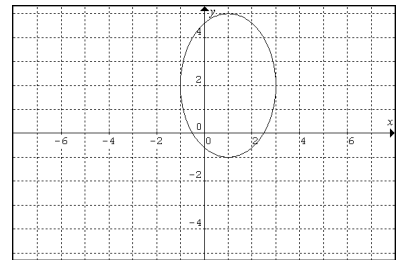

Center:  $(1, 2)$

Vert:  $(1, 5), (1, -1)$

x-int:

$$\left(1 \pm \frac{2\sqrt{5}}{3}, 0\right) \approx (2.5, 0), (-0.5, 0)$$

y-int:  $(0, -1/2), (0, 4\frac{1}{2})$

19.

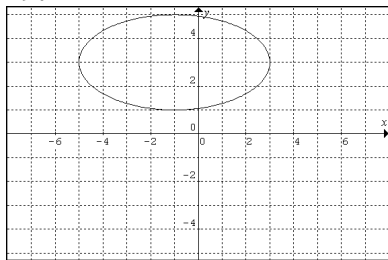

Center:  $(-1, 3)$

Vert:  $(3, 3), (-5, 3)$

x-int: none

y-int:

$$\left(0, 3 \pm \frac{\sqrt{15}}{2}\right) \approx (0, 4.9), (0, 1.1)$$

21.

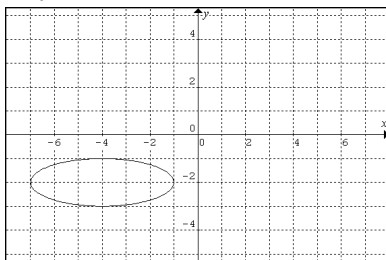

Center:  $(-4, -2)$

Vert:  $(-1, -2), (-7, -2)$

x-int: none

y-int: none

23.

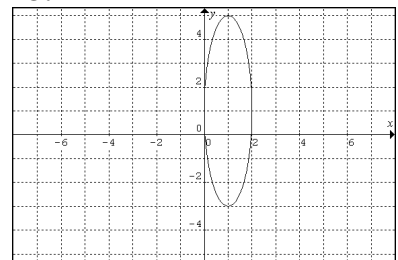

Center:  $(1, 1)$

Vert:  $(1, 5), (1, -3)$

x-int:

$$\left(1 \pm \frac{\sqrt{15}}{4}, 0\right) \approx (0.03, 0), (1.97, 0)$$

y-int:  $(0, 1)$

25.

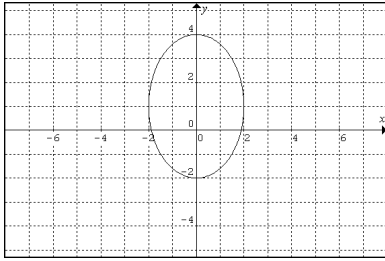

Center: (0, 1)

Vert: (0, -2), (0, 4)

x-int:  $\left(\pm \frac{4\sqrt{2}}{3}, 0\right) \approx (\pm 1.9, 0)$

y-int: (0, -2), (0, 4)

27.

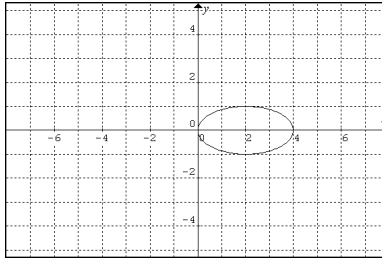

Center: (2, 0)

Vert: (0, 0), (4, 0)

x-int: (0, 0), (4, 0)

y-int: (0, 0)

29.

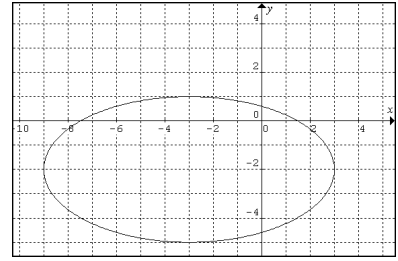

Center: (-3, -2)

Vert: (3, -2), (-9, -2)

x-int:

$\left(-3 \pm 2\sqrt{5}, 0\right) \approx (-7.5, 0), (1.5, 0)$

y-int:

$\left(0, -2 \pm \frac{3\sqrt{3}}{2}\right) \approx (0, -4.6), (0, 0.6)$

31.

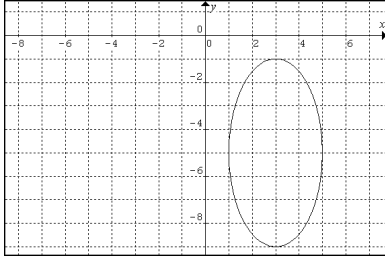

Center: (3, -5)

Vert: (3, -1), (3, -9)

x-int: none

y-int: none

33.

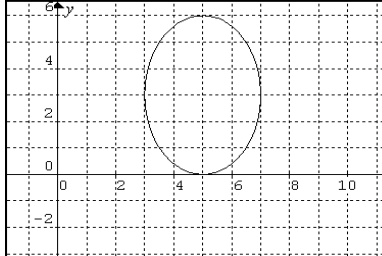

Center: (5, 3)

Vert: (5, 0), (5, 6)

x-int: (5, 0)

y-int: none

35.

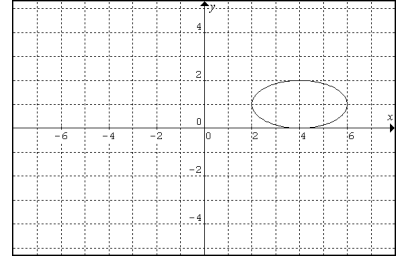

Center: (4, 1)

Vert: (6, 1), (2, 1)

x-int: (4, 0)

y-int: none

37.

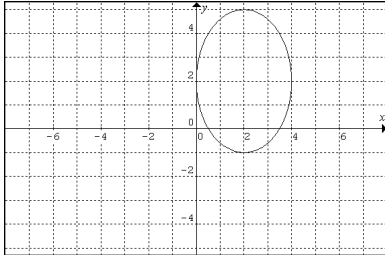

Center: (2, 2)

Vert: (2, 5), (2, -1)

x-int:

$\left(2 \pm \frac{2\sqrt{5}}{3}, 0\right) \approx (3.5, 0), (0.5, 0)$

y-int: (0, 2)

39.

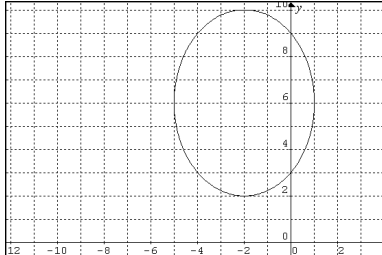

Center: (-2, 6)

Vert: (-2, 2), (-2, 10)

x-int: none

y-int:

$\left(0, 6 \pm \frac{4\sqrt{5}}{3}\right) \approx (0, 8.98), (0, 3.02)$

41.

Circle

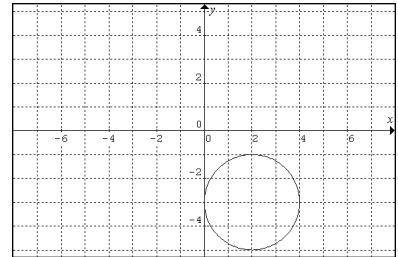

43.

Parabola

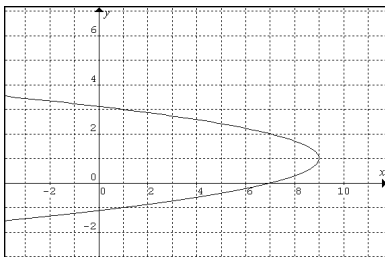

45.

Parabola

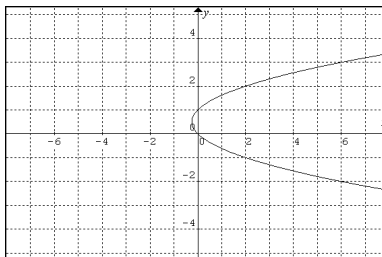

47.

Ellipse

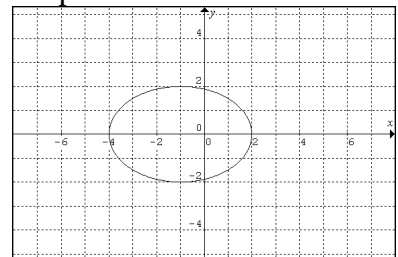

**49.**  
Circle

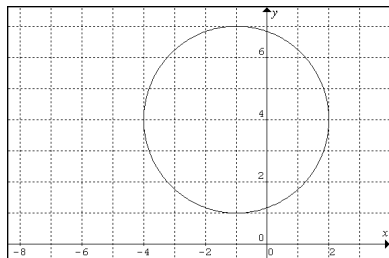

**51.**  
Ellipse

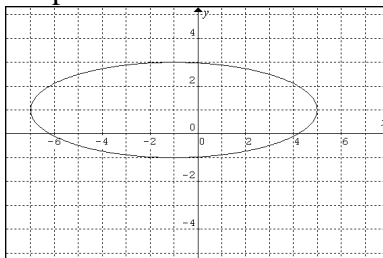

53.  $\frac{(x-2)^2}{4} + \frac{(y+3)^2}{9} = 1$     55.  $\frac{(x-2)^2}{9} + \frac{5(y+4)^2}{9} = 1$     57.  $\frac{(x-1)^2}{4} + (y-2)^2 = 1$

59.  $8\pi \approx 25.1$     61.  $6\pi \approx 18.8$     63.  $2\pi \approx 6.3$

**Section 12.5**

**1.**

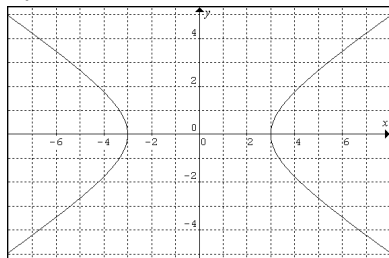

Center: (0, 0)  
Vert: (3, 0), (-3, 0)  
x-int: (3, 0), (-3, 0)  
y-int: none

**3.**

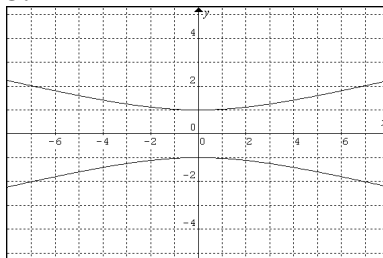

Center: (0, 0)  
Vert: (0, 1), (0, -1)  
x-int: none  
y-int: (0, 1), (0, -1)

**5.**

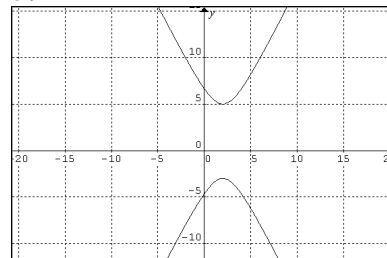

Center: (2, 1)  
Vert: (2, 5), (2, -3)  
x-int: none  
y-int:  
 $(0, 1 \pm 4\sqrt{2}) \approx (0, 6.7), (0, -4.7)$

**7.**

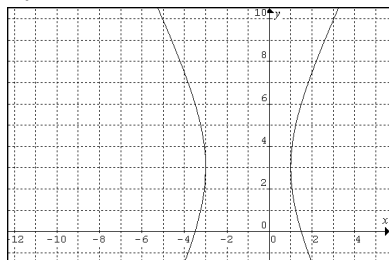

Center: (-1, 3)  
Vert: (-3, 3), (1, 3)  
x-int:  
 $(-1 \pm \frac{3\sqrt{3}}{2}, 0) \approx (-3.6, 0), (1.6, 0)$   
y-int: none

**9.**

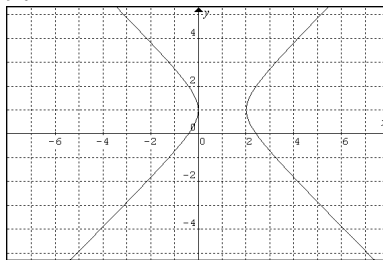

Center: (1, 1)  
Vert: (0, 1), (2, 1)  
x-int:  
 $(1 \pm \sqrt{2}, 0) \approx (2.4, 0), (-0.4, 0)$   
y-int: (0, 1)

**11.**

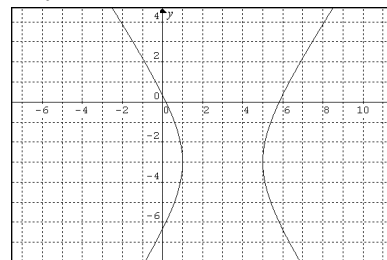

Center: (3, -3)  
Vert: (5, -3), (1, -3)  
x-int:  
 $(3 \pm \frac{6\sqrt{2}}{3}, 0) \approx (5.8, 0), (0.2, 0)$   
y-int:  
 $(0, -3 \pm \frac{3\sqrt{5}}{2}) \approx (0, -6.4), (0, 0.4)$

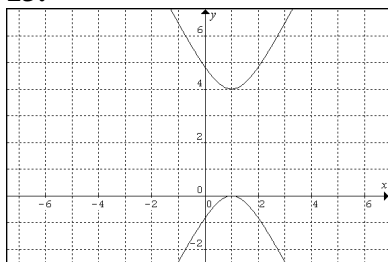

**13.**

Center: (1, 2)

Vert: (1, 0), (1, 4)

x-int: (1, 0)

y-int:

$$(0, 2 \pm 2\sqrt{2}) \approx (0, -0.8), (0, 4.8)$$

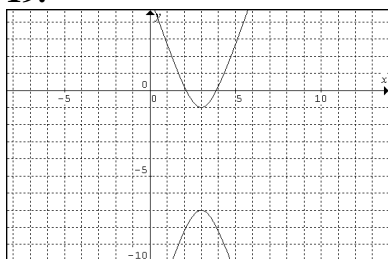
**19.**

Center: (3, -4)

Vert: (3, -1), (3, -7)

x-int:

$$\left(3 \pm \frac{\sqrt{7}}{3}, 0\right) \approx (3.9, 0), (2.1, 0)$$

y-int:

$$(0, -4 \pm 3\sqrt{10}) \approx (0, -13.5), (0, 5.5)$$

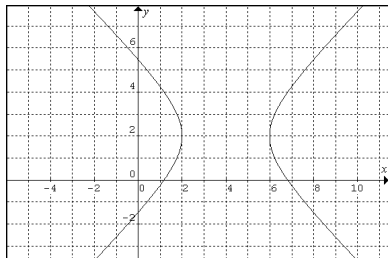
**25.**

Center: (4, 2)

Vert: (6, 2), (2, 2)

x-int:

$$(4 \pm 2\sqrt{2}, 0) \approx (6.8, 0), (1.2, 0)$$

y-int:

$$(0, 2 \pm 2\sqrt{3}) \approx (0, -1.5), (0, 5.5)$$

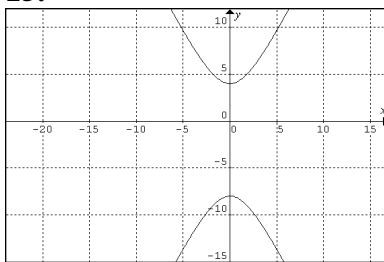
**15.**

Center: (0, -2)

Vert: (0, 4), (0, -8)

x-int: none

y-int: (0, 4), (0, -8)

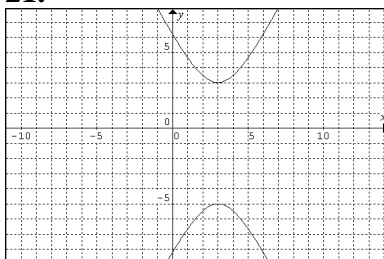
**21.**

Center: (3, -1)

Vert: (3, 3), (3, -7)

x-int: none

y-int:

$$(0, -1 \pm 2\sqrt{13}) \approx (0, -8.2), (0, 6.2)$$

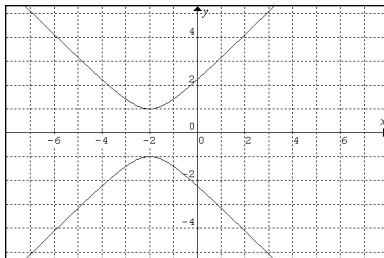
**27.**

Center: (-2, 0)

Vert: (-2, 1), (-2, -1)

x-int: none

$$y\text{-int: } (0, \pm\sqrt{5}) \approx (0, \pm 2.2)$$

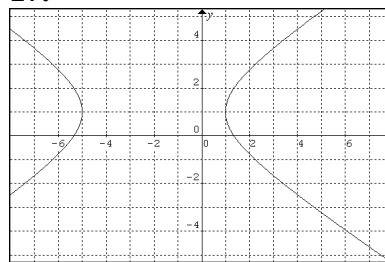
**17.**

Center: (-2, 1)

Vert: (1, 1), (-5, 1)

x-int:

$$\left(-2 \pm \frac{3\sqrt{5}}{2}, 0\right) \approx (-5.4, 0), (1.4, 0)$$

y-int: none

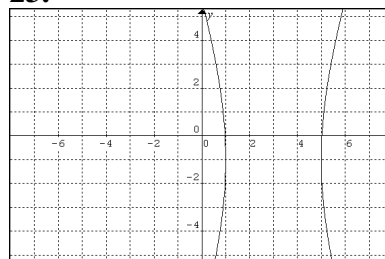
**23.**

Center: (3, -1)

Vert: (5, -1), (1, -1)

x-int:

$$\left(3 \pm \frac{\sqrt{37}}{3}, 0\right) \approx (5.03, 0), (0.97, 0)$$

y-int:

$$(0, -1 \pm 3\sqrt{5}) \approx (0, -7.7), (0, 5.7)$$

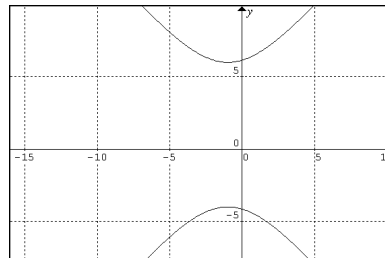
**29.**

Center: (-1, 1)

Vert: (-1, -4), (-1, 6)

x-int: none

y-int:

$$\left(0, 1 \pm \frac{5\sqrt{17}}{4}\right) \approx (0, -4.2), (0, 6.2)$$

31.

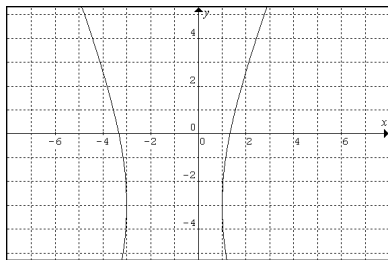

Center: (-1, -3)

Vert: (1, -3), (-3, -3)

x-int:

$$\left(-1 \pm \frac{2\sqrt{34}}{5}, 0\right) \approx (1.3, 0), (-3.3, 0)$$

y-int: none

37.

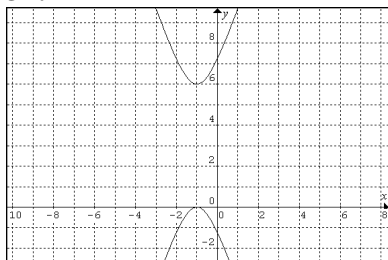

Center: (-1, 3)

Vert: (-1, 0), (-1, 6)

x-int: (-1, 0)

y-int:

$$(0, 3 \pm 3\sqrt{2}) \approx (0, -1.2), (0, 7.2)$$

43.

Circle

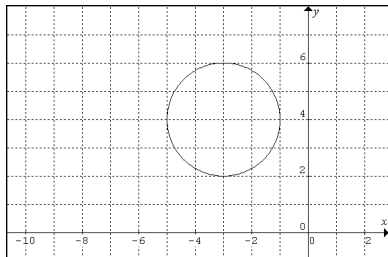

49.

Hyperbola

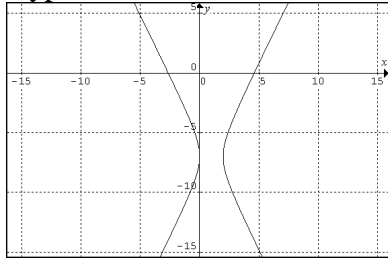

33.

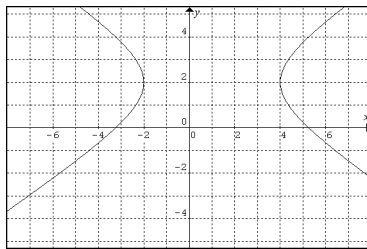

Center: (1, 2)

Vert: (-2, 2), (4, 2)

x-int:

$$(1 \pm 3\sqrt{2}, 0) \approx (5.2, 0), (-3.2, 0)$$

y-int: none

39.

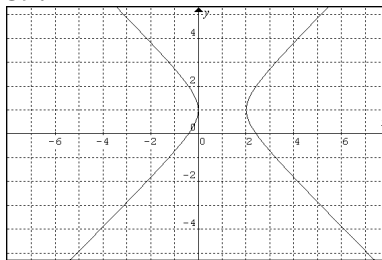

Center: (1, 1)

Vert: (0, 1), (2, 1)

x-int:

$$(1 \pm \sqrt{2}, 0) \approx (2.4, 0), (-0.4, 0)$$

y-int: (0, 1)

45.

Hyperbola

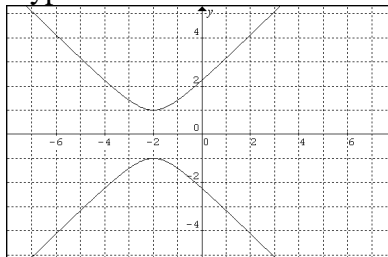

35.

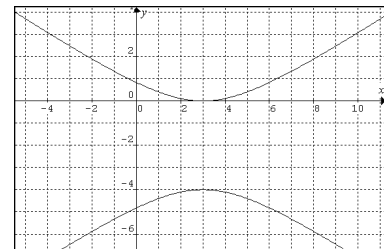

Center: (3, -2)

Vert: (3, 0), (3, -4)

x-int: (3, 0)

y-int:

$$(0, -2 \pm 2\sqrt{2}) \approx (0, -4.8), (0, 0.8)$$

41.

Parabola

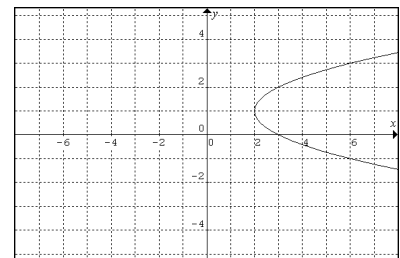

47.

Ellipse

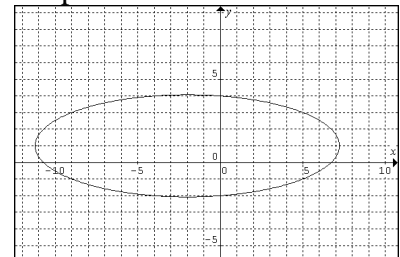

51.

Ellipse

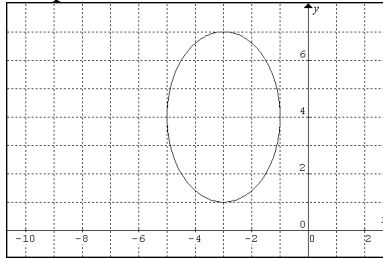

53.

Parabola

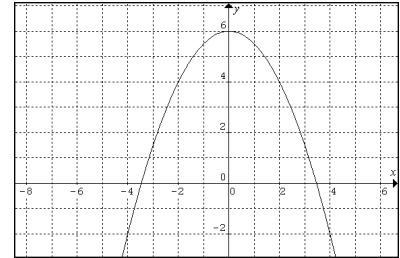

55.

Hyperbola

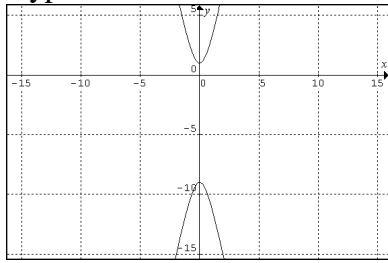

57.  $\frac{(x+1)^2}{4} - \frac{(y-2)^2}{9} = 1$

59.  $\frac{(y-5)^2}{4} - \frac{21(x+1)^2}{4} = 1$

61.  $(y - \frac{7}{2})^2 - (x+1)^2 = 1$  or  $(y - \frac{5}{2})^2 - (x+1)^2 = 1$